

FCD803S-RGBW



FCD803S-RGBW, an 8 inch square inground recessed luminaire with a stainless steel faceplate. This IP67 rated fixture is perfect for exterior use and inground applications. With its versatile RGBW and Tunable White color temperature options, along with a wide range of beam spreads, this luminaire offers customizable lighting solutions. The durable construction, including a marine-grade, corrosion-resistant aluminum housing and a clear tempered lens, ensures long-lasting performance. With its high lumen output and excellent lumen maintenance, this luminaire provides reliable and efficient lighting. The **FCD803S-RGBW** is compatible with various control systems, including DMX 512 and RDM, allowing for seamless integration into any lighting design. Backed by a 5-year limited warranty, this luminaire is a reliable and high-quality choice for any outdoor lighting project.



SPECIFICATIONS	
color temperature	RGBW, Tunable White
PHYSICAL	
beam spread	LED optics: Spot-10°, Narrow Flood-30°, Flood-60°, Wide Flood-80°, ASYM-15°x90° (image-free white lens)
length/dimension	fixture: 8.8" Ø x 11.0" D, PVC well housing: 8.4" Ø x 11.0" D
weight	9.25 lbs
housing	marine grade, corrosion-resistant, high pressure aluminum (includes mounting sleeve)
lens	standard: 3/8" thick clear tempered, optional: SR = Slip Resistance, etched lens on outer surface
mounting	concrete pour installation (mounting sleeve included) - drainage required (improperly installed luminaires will void warranty)
ingress protection	silicone continuous gasket to seal out contaminants, dry, damp or wet locations IP67 rated
construction	316 grade machined brushed stainless steel trim
PERFORMANCE	
lumen output	1100 lm (All Color Channels On)
lumen maintenance	L70 > 70,000 hours
CCT modes	RGBW, RGBW & Tunable White, Tunable White
operating temperature	-4°F to 122°F (-20°C to 50°C)
protocols	DMX 512, RDM (ANSI E1.20)
ColourQuick (CQ)	provides uniform beam saturation instantaneously without scalloping
ColourClone (CC)	manufacturing process uses robotic systems to provide 1 SDCM like consistency between luminaires by calibrating every luminaire to the same exact X, Y, chromaticity coordinates
ColourSoft (CS)	embedded firmware enables 16-bit resolution using only 8-bits of data to enhance the low trim curve for no-flicker at the slowest transition speeds
ColourMode (CM)	RGBW and Tunable White in one luminaire using 6 DMX channels Channels 1-4 - RGBW, Channels 5-6* - Tunable White (Channel 5 = intensity and Channel 6 = CCT) <i>*Tunable White mode must use the entire luminaire as one unit</i>
warranty	5-Year limited warranty
ELECTRICAL	
input voltage	Universal 120 - 277 VAC
power supply	integral Class II, electronic high-power factor 99% @ 120V
controls	SSL color controller, 3rd party DMX 512, RDM standard based control system
certification	ETL / cETL Listed, FCC-Part 15 Class A
standards	UL1598 / CSA C22.2 No. 250.0 - Class I / IES LM-79 / LM-80



Ordering Information

ORDERING INFORMATION

SERIES	VOLTAGE	COLOR	FINISH	LED OPTICS	OPTIONS
FCD803S-RGBW	UNV		SS		
	UNV	120 - 277 VAC			
		RGBW RGBW	SS Stainless Steel	SP Spot (10°)	DMX DMX Protocol (Required)
		RGBW-TW RGBW & Tunable White		NFL Narrow Flood (30°)	SR Slip Resistant (Frosted Lens)
		TW Tunable White		FL Flood (60°)	RG Rock Guard (not drive over rated)
				WFL Wide Flood (80°)	LPVC Less PVC Well Housing (For shipment separate of PVC Well Housing)
				ASYM Asymmetrical (15°x90°)	

Well Housings (order separately)

99122 FCD803 PVC Well Housing - Shipped in advance of luminaire.

Cable Accessories (order separately)

REQUIRED: Each run requires a Field-Installed Data Terminator.

TCAPFIELD Field-Installed Data Terminator (W/ 120 OHM Resistor)

Control Components (Indicate the quantity needed for each item.)

- _____ **PDX2** Power Data Wiring Box (*exterior rated*)
- _____ **PDX-RDS2** Power Data Wiring Box w/2-port splitter
- _____ **PDX-RDS4** Power Data Wiring Box w/4-port splitter
- _____ **CL-RS4** 4 Port RDM splitter w/120V power supply
- _____ **SCSC-1WH** White Wall Mount ColourSelect Controller (*1 universe*)
- _____ **SCSC-2WH(2BK)** White or Black Wall Mount ColourSelect Controller (*2 universe*)
- _____ **CSC-1** ColourSelect Controller (*1 universe*)
- _____ **CSC-2** ColourSelect Controller (*2 universe*)
- _____ **PS-CSC** Power Supply for CSC-1 / -2
- _____ **DE3BK(WH)** Nicolaudie STICK DE-3 Black or White Wall Mount Controller w/color dial
- _____ **KE2-BK** Nicolaudie STICK Black Touch Screen Wall Mount Controller
- _____ **CW4-WH** Nicolaudie STICK White Touch Screen with Internal WiFi
- _____ **GA2WH(BK)** Nicolaudie STICK-GA2 White or Black Wall Mount Controller
- _____ **PHAROS TPC-BN** Touch Panel Controller - Black on Nickel (*512 Channels EDMX*)
- _____ **PHAROS TPC-FBB** Flush Mount Back box for drywall installation
- _____ **PHAROS TPC-SBB** Surface Mount Back box for drywall installation
- _____ **PHAROS EXT** Extension for TPC Connectivity
- _____ **PHAROS LPC1** Lighting Playback Controller 1 (512 channels DMX/eDMX)
- _____ **PHAROS LPC2** Lighting Playback Controller 2 (1,024 channels DMX/eDMX)
- _____ **DXC-25** 25 foot DMX cable
- _____ **DXC-50** 50 foot DMX cable
- _____ **DXC-100** 100 foot DMX cable
- _____ **CD-10** 10 foot controller data cable (for CSC only)
- _____ **CD-25** 25 foot controller data cable (for CSC only)
- _____ **CD-50** 50 foot controller data cable (for CSC only)
- _____ **CD-100** 100 foot controller data cable (for CSC only)
- _____ **5900** Multiverse Show Baby DMX Wireless Bridge (Indoor)
- _____ **7400-5707M** Show DMX Vero DMX Wireless Bridge (Exterior)

*Controller Data Cables/DMX Cables listed are exterior rated cables.
(Belden 3105A or equivalent) CD cables have male XLR at one end.*





Dimensions

PRODUCT DIMENSIONS - STANDARD PRODUCT

width	8.8" Ø
depth	11.0" D

marine grade aluminum housing
with 316 stainless steel faceplate

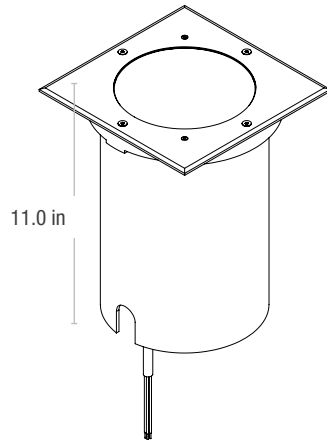
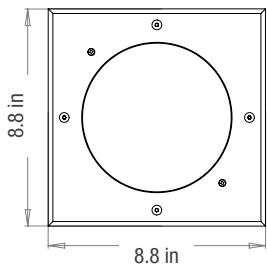

MOUNTING - *mounting sleeve included, one per fixture*

PVC housing	8.4" Ø
well housing depth	11.0" D

french drain
required
for proper
installation,
see installation
instructions

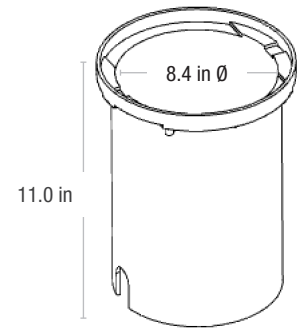

ACCESSORIES

RG - Rock Guard	8.75" Ø
add to fixture (above ground)	.5" D

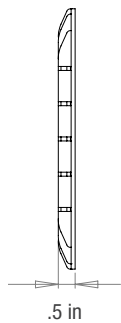
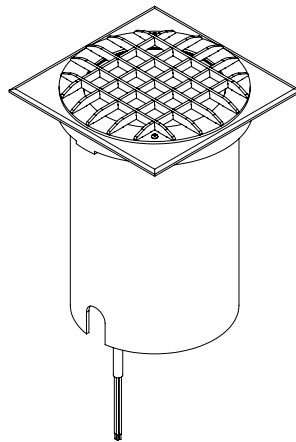
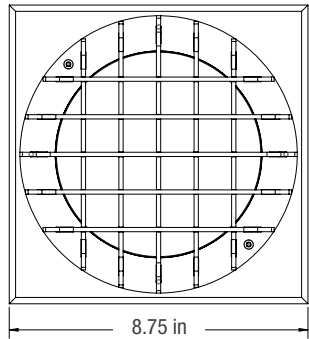



OPTICAL DISTRIBUTION

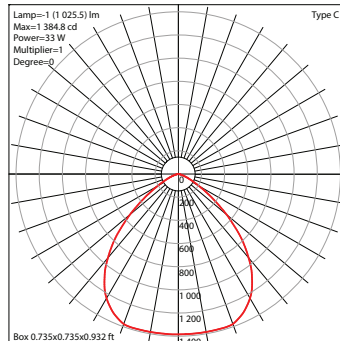
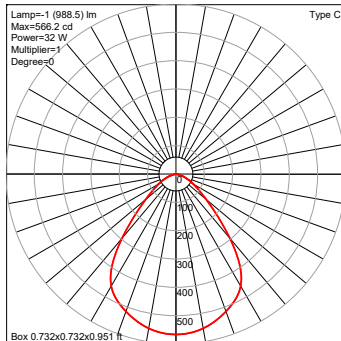
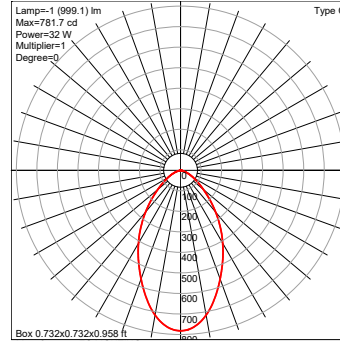
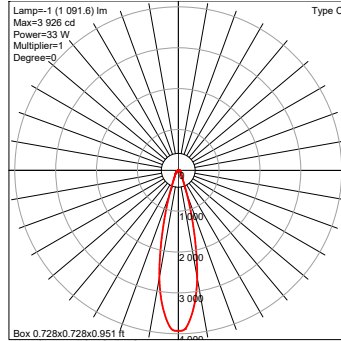
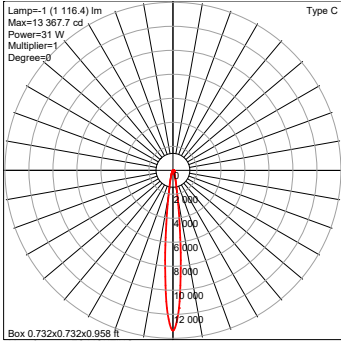

* Slip-Resistant Lens option results in 0.83 lumen multiplier.



ColourQuick

RAPID-MIX COLOR

- Instantaneous Color Mixing – Within 1 inch
- Shortest Distance in Industry for Blending Colors
- 4-in-1 RGBW LED designed to SSL Specifications

ColourLine RGBW fixtures provide the quickest color mixing in the industry. The SSL ColourQuick technology enables our ColourLine Linear Indoor Cove and Graze, as well as, our Outdoor Floods to color-mix almost instantly, within one inch.



ColourClone

TRU-COLOR RGBW MATCHING

- Robotic Calibration of every fixture provides 1-Step consistency
- Every fixture has same X, Y color coordinates
- Perfect match for add-ons and replacements

As part of our manufacturing process, SSL Automated Manufacturing Robots calibrate every fixture to the exact same X,Y color coordinates to provide Step-1 like consistency. This process enables every fixture to be an exact clone. At the end of the process, a bar code is generated for every board. This allows for exact matching for job add-ons or warranty replacements.



ColourSoft

SMOOTH LOW-TRIM DIMMING

- Flicker-Free Color Transitions and Dimming
- 16-bit performance (65,536 steps) using *only 8-bit addressing*
- SSL Engineered Custom Software and Firmware

Standard dimming technology uses 8-bit resolution for 256 individual steps. Our 32-bit on-board MCU uses SSL developed software to provide 16-bit resolution that allows 65,536 steps of resolution and only use 8-bits of addressing space! We also use a logarithmic delineation of the resolution to concentrate in the lower third of the dimming curve so the low-end dimming and color transitions have zero flicker.



ColourMode

RGBW AND TUNABLE WHITE IN ONE

- SSL Designed Firmware uses 6 DMX Channels
- RGBW and Tunable White (2-Step, >90CRI) in One Fixture
- 5 Distinct Fixture Personalities for - Maximum Flexibility

SSL uses Digital Dual Mode (DDM) technology to provide RGBW and Tunable White in one fixture! SSL firmware is designed to use 6 DMX channels in the DDM Personality Mode. Maximum Mood Enhancement is available to use for any type of environment. Channels 1-4 are reserved for RGBW. Channels 5-6 are used for White color tuning. Channel 5 controls intensity, channel 6 controls White color.

Scalable

- Full DMX, RDM control capability with latest industry standards
- A wide variety of DMX protocol controls and system accessories
- SSL has many RGBW products utilizing the ColourLine Technology
- Multiple personality settings to enhance RGBW & Tunable White
- Control 1000's of DMX channels with multiple universes & zones
- Powerful luminaires with super optics for long-throw applications
- SSL provides turnkey design and technical integration support



Wiring Configurations

SINGLE SEGMENT CONFIGURATION EXAMPLES

STANDARD CONFIGURATION

- 1) DMX-RDM Controller
- 2) DMX Data Cable **DXC-xx** or **CD-xx** (CSC only)
- 3) RGBW Flood (with standard 5-Pin cord whip)
- 4) Controller Data Cables/DMX Cables are exterior rated (by others). (Belden 3105A or equivalent) CD-XX cables have male XLR at one end.

AC Power - Supplied by others in various methods; to each fixture separately, in separate conduits, or in the same conduit (Cables with same voltage rating).

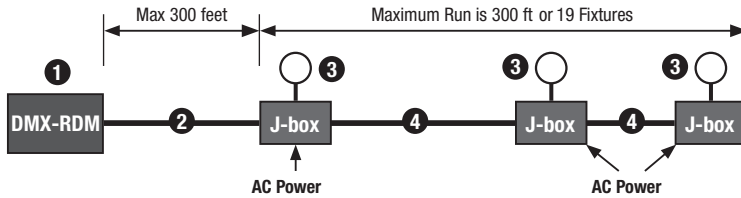

GENERAL:

1. All electrical connections must be in accordance with codes, ordinances, or the National Electrical Code.
2. Before starting the installation, make sure all the electricity has been turned off and the electrical breaker has been locked out and tagged out.
3. To ensure the success of the installation, be sure to read these instructions and review the diagrams thoroughly before beginning.
4. Do not exceed the fixture specified voltage.
5. The fixture cord should be fed through the top knockout hole of the jbox.

NOTE: The important safeguards and instructions appearing in this manual are not meant to cover all possible conditions and situations that may occur.

INSTALLATION:

- 1) Verify Physical Layout Plan
 - a) Ensure all hardware is present.
 - b) Ensure all electrical feeds are correctly positioned with all hardware and any other active components.
 - c) Confirm DMX Addressing Plan
 - i. SSL recommends pre-addressing fixtures before mounting installation.
 - ii. Ensure that addressing is documented for future upgrading, configuring or troubleshooting.
 - iii. Create an addressing table to document all fixture IDs and their physical location.

Notice

- Maximum of 32 DMX/RMS enabled fixtures per run
- UL wiring details shown
- DMX terminator is required at the end of each run to maintain data integrity

WIRING DIAGRAM AT JUNCTION BOX - FOR UL OR CE OPTIONS

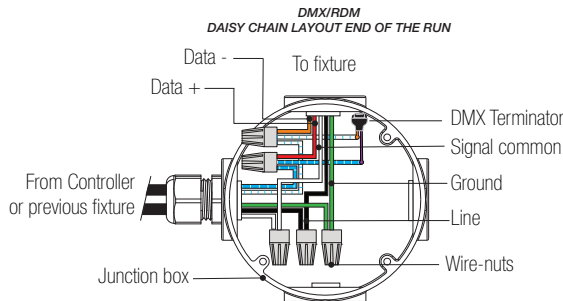
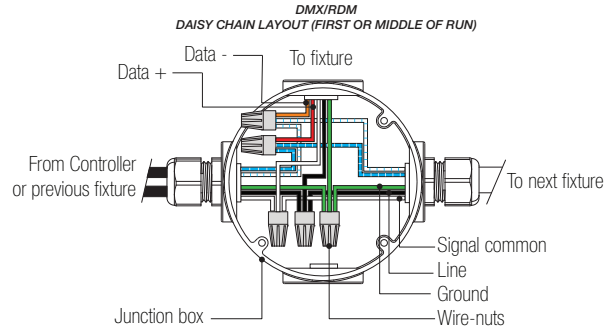

Wiring Color Code

UL Color Code	CE Color Code	USE
Green	Yellow/Green	Ground
Black	Brown	Line (120 - 277 VAC)
White	Blue	Line/Neutral
Red/Blue	Purple	Data +
Orange/White	Orange	Data -