

FCW1011, EXTERIOR SURFACE DOWNLIGHT — INSTALLATION INSTRUCTIONS

CAUTION: BEFORE CONNECTING THE LUMINAIRE TO A POWER SUPPLY, MAKE SURE THE POWER IS SWITCHED OFF.

DETAILED ILLUSTRATION



GENERAL:

1. Before starting the installation, make sure all electricity has been turned off and electrical breaker has been locked out and tagged out.
2. To ensure the success of the installation, be sure to read these instructions and review the diagrams thoroughly before beginning.
3. All electrical connections must be in accordance with local codes, ordinances, or the National Electrical Code.
4. These luminaires are intended to be mounted directly to the building structure, over the electrical junction box or conduit outing.
5. All luminaires to be installed by a qualified electrician.

NOTE: The important safeguards and instructions appearing in this manual are not meant to cover all possible conditions and situations that may occur.

INSTALLATION:

1. Use a 9/64" Hex tool to remove the four screws located on either side of the luminaire. Place the screws in a safe location. (Figure 1)
2. Carefully remove the front cover from the luminaire. (Figure 2)
3. Affix the backplate to the wall. Installers can either affix via surface-mounting holes or attach directly to the junction box. (Figure 3)

NOTE: Use Junction Box mounting screws (6-32, third-party hardware) to secure the mounting plate to the Junction Box on the intended Surface.

WARNING: LED lamping is integral and NOT intended for general servicing. Luminaire is designed to work with standard size J-boxes, sizes may vary.

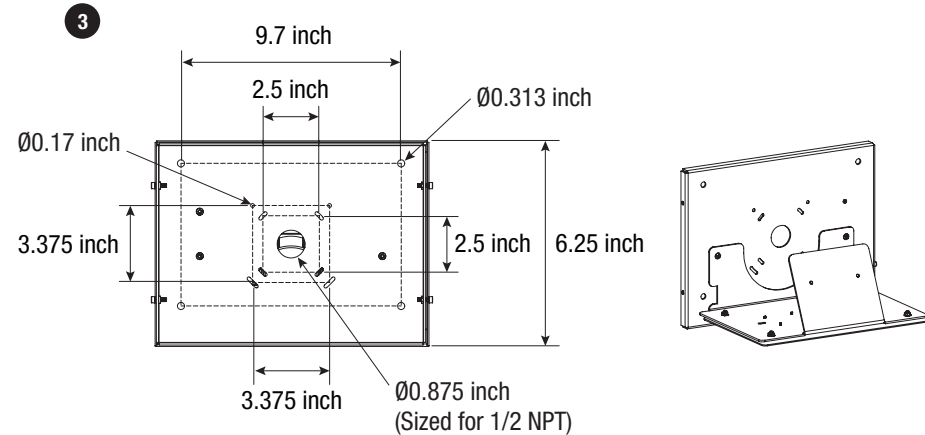
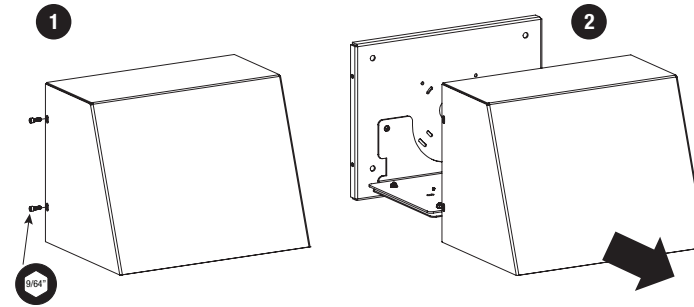

FCW1011, EXTERIOR SURFACE DOWNLIGHT — INSTALLATION INSTRUCTIONS

CAUTION: BEFORE CONNECTING THE LUMINAIRE TO A POWER SUPPLY, MAKE SURE THE POWER IS SWITCHED OFF.

DETAILED ILLUSTRATION



GENERAL:

1. Before starting the installation, make sure all electricity has been turned off and electrical breaker has been locked out and tagged out.
2. To ensure the success of the installation, be sure to read these instructions and review the diagrams thoroughly before beginning.
3. All electrical connections must be in accordance with local codes, ordinances, or the National Electrical Code.
4. These luminaires are intended to be mounted directly to the building structure, over the electrical junction box or conduit outing.
5. All luminaires to be installed by a qualified electrician.

NOTE: The important safeguards and instructions appearing in this manual are not meant to cover all possible conditions and situations that may occur.

INSTALLATION:

4. Feed power and dimming wires through backplate, connect wires to luminaire. (**Figure 4**)
 - Black — Line
 - White — Neutral
 - Green — Ground
 - Purple — Dim+
 - Pink — Dim-
5. Replace the cover the backplate and secure to wall using a 9/64" Hex tool. When fastening security screws, tighten to 20 in-lbs. (**Figure 5**)
6. Installer **MUST** add a bead of silicon where back edge of luminaire housing meets the mounting surface. (**Figure 6**)

WARNING: LED lamping is integral and NOT intended for general servicing. Luminaire is designed to work with standard size J-boxes, sizes may vary.

