

FCSL105A



FCSL105A Exterior Die-Cast Brick Light for masonry applications with Die-Cast Horizontal Louvered Faceplate and Wildlife Friendly LED.



Wildlife Lighting Certified
by the Florida Fish & Wildlife
Conservation Commission

ORDERING

FCW105A		AM	1L		
SERIES	VOLTAGE	CCT	LUMENS	FINISH	OPTIONS
FCSL105A	120V 120 VAC 277V 277 VAC	AM Amber	1L 71 lm (10.5W)	BKE Black BRE Bronze GRE Graphite Grey CCE Custom Color	HB Hanger Bracket LBB Less Back Box (for shipment separate of Back Box)

BACK BOX KITS

H99001-ETL Back Box Kit - Complete Back Box shipped in advance of fixture without mounting kit.

REMOTE DRIVER & BATTERY BACKUP

FCW105AR		AM	1L		
SERIES	VOLTAGE	CCT	LUMENS	FINISH	OPTIONS
FCSL105AR[†]	120V 120 VAC 277V 277 VAC	AM Amber	1L 71 lm (10.5W)	BKE Black BRE Bronze GRE Graphite Grey CCE Custom Color	HB Hanger Bracket LBB Less Back Box (for shipment separate of Back Box) BBUR¹ Battery Backup Remote (Indoor) BBUX² Battery Backup Remote (Outdoor) N/A Leave Blank for Remote Driver Only (without Battery Backup)

[†] LED DRIVER REMOTE (INDOOR), IP20, IK08, NEMA 1, -20°C to +50°C, 30' MAX Distance with 12AWG.
* Consult factory for outdoor remote driver only.

¹ Battery Back-up & LED Driver Remote (INDOOR), IP20, IK08, NEMA 1, 0°C to +48°C, 30' MAX Distance with 12AWG (w/UNV Option Only)
² Battery Back-up & LED Driver Remote (OUTDOOR), IP67, IK10, NEMA 4X, -20°C to +55°C, 30' MAX Distance with 12AWG (w/UNV Option Only)

SPECIFICATION

MOUNTING

- Concrete pour standard. Use HB accessory for drywall applications.

CONSTRUCTION

- Marine grade, corrosion resistant, heavy walled, high pressure die-cast aluminum construction.
- Clear tempered glass lens. Precision formed semi-specular aluminum reflector.
- Neoprene continuous closed cell urethane 'O' ring gasket. Captive and recessed stainless steel, tamper resistant hex socket screws.

LED

- Lumens stated are the minimum delivered out of the luminaire. LED lifetime is greater than 70,000 hours with the lumen depreciation greater than L70.
- Integral power supply standard. Input voltage 120V or 277V standard.
- LED is Sea Turtle and Wildlife friendly with a minimum 560 nm wavelength.

ELECTRICAL

- Driver UL listed driver standard. Driver has a manufacturer issued warranty up to 5 years. Please consult factory for other voltage options.

FINISH

- Six stage chemical iron phosphate conversion pre-treatment. Polyester powder coat finish, 18 µm Min., 5000hr salt spray test (ASTM B117) compliant with Florida / AAMA 2604 specification.

LISTING

- ETL, U.S. and CA listed for interior and exterior wet locations. IP65 rating. Wildlife Friendly Lighting Certification #2018-049

Due to continuous development and improvements, specifications are subject to change without notice. FC Lighting reserves the right to change lab test details or specifications without notice. Product use certifies agreement to FC terms and conditions.



PHOTOMETRY

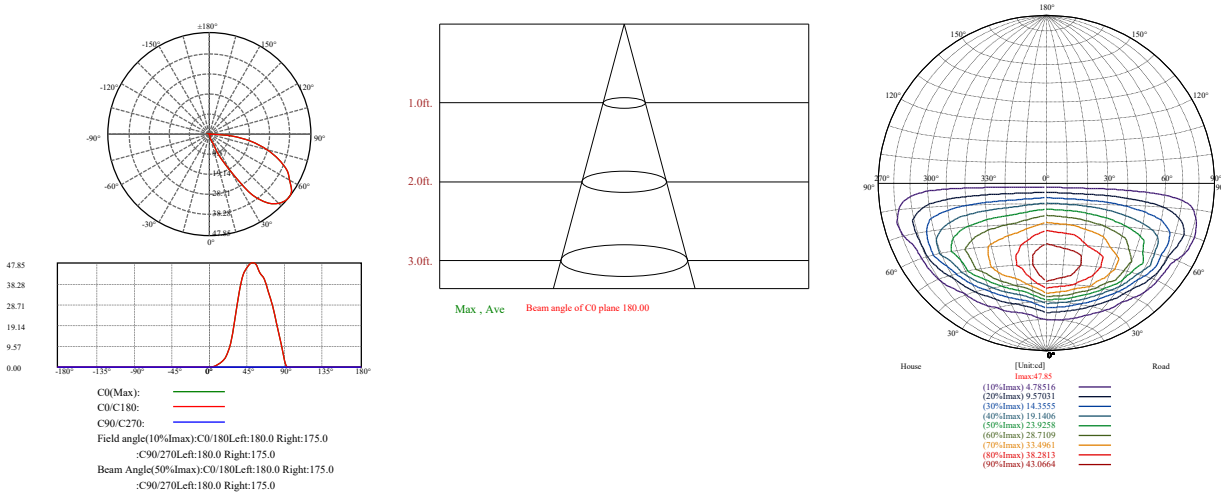

Spectroradiometric Parameters

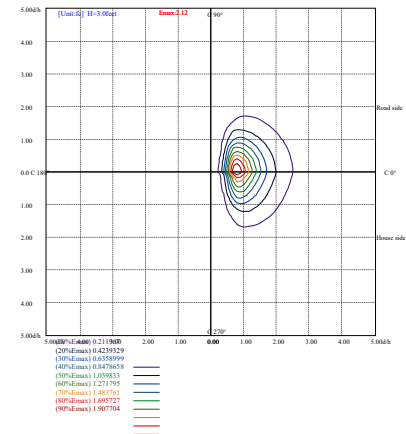
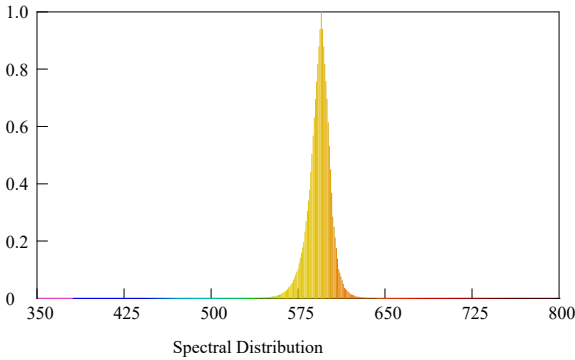

DIMENSIONS

FCSL105A

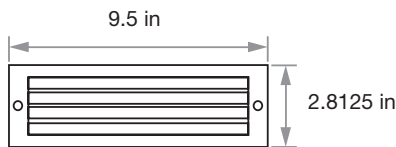

UNIVERSAL HOUSING

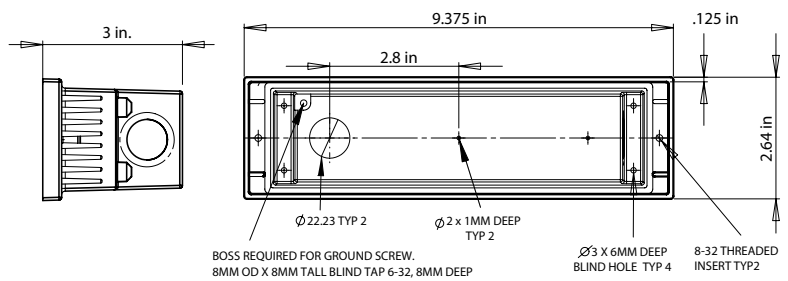

Due to continuous development and improvements, specifications are subject to change without notice. FC Lighting reserves the right to change lab test details or specifications without notice. Product use certifies agreement to FC terms and conditions.

BATTERY BACK-UPS

BBUR - BATTERY BACK-UP & LED DRIVER REMOTE (INDOOR), IP20, IK08, NEMA 1, 0°C to +48°C, 30' MAX Distance with 12AWG (w/UNV Option Only)

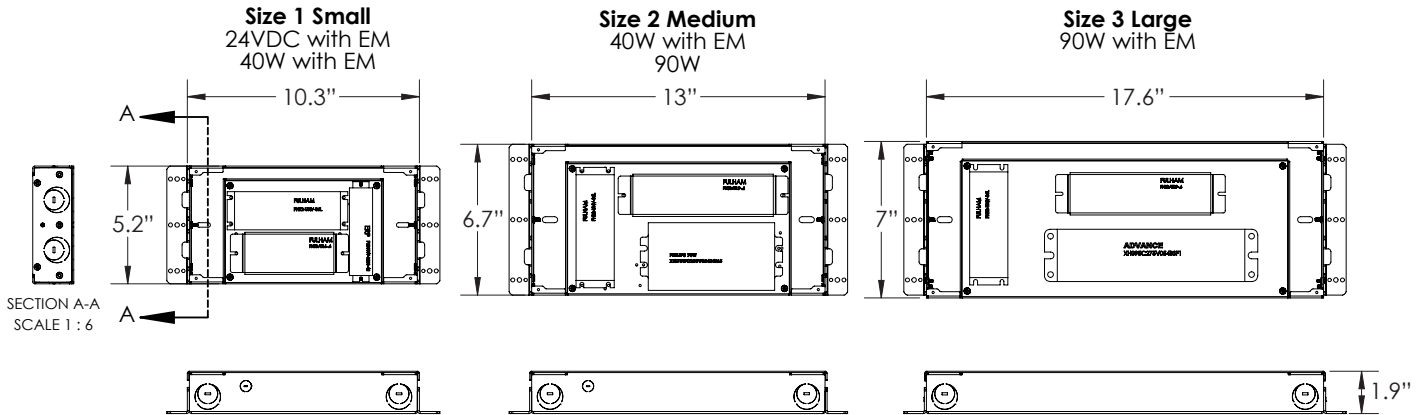

BBUX - BATTERY BACK-UP & LED DRIVER REMOTE (OUTDOOR), IP67, IK10, NEMA 4X, -20°C to +55°C, 30' MAX Distance with 12AWG (w/UNV Option Only)

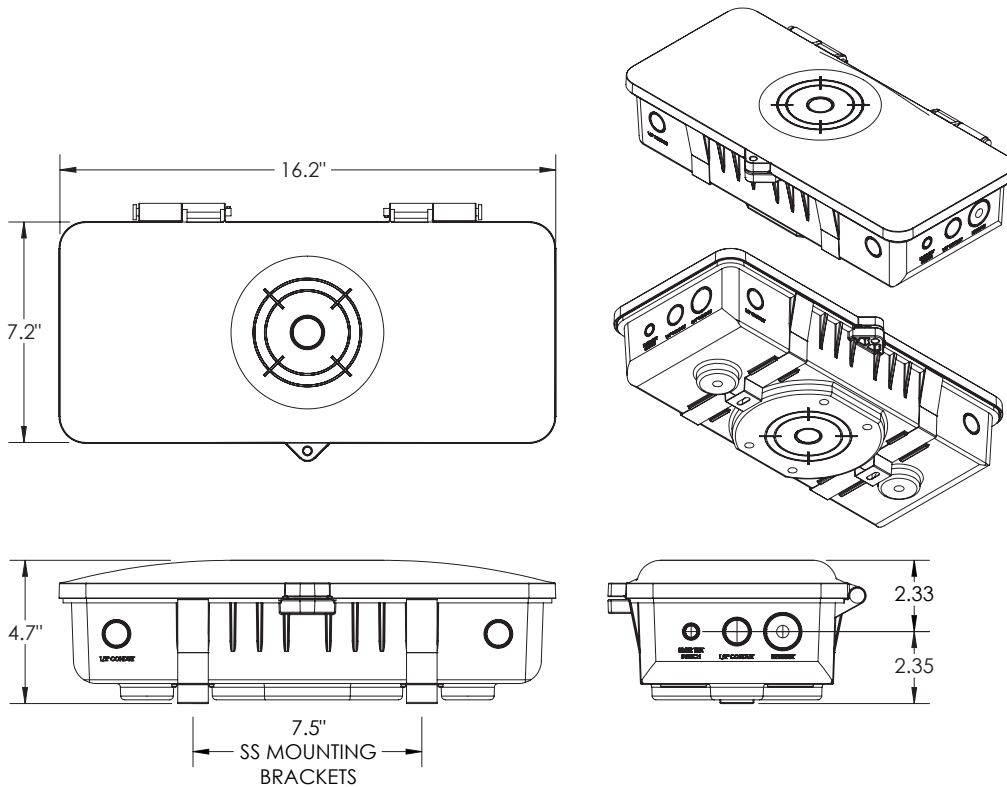

Due to continuous development and improvements, specifications are subject to change without notice. FC Lighting reserves the right to change lab test details or specifications without notice. Product use certifies agreement to FC terms and conditions.