



FCD481

Single Direction

6" Round Directional
Drive-over LED Inground.



Date:	Approved:
Type:	
Fixture:	
Project:	

ORDERING

EXAMPLE: FCD481-120V-4K-1L-SL-F-PVC

FCD481			1L				
SERIES	VOLTAGE	CCT	LUMENS	Finish	ACCESSORIES		
FCD481	120V	27K 2700K	1L 165 lm (4W)	BK Black	PVC PVC Housing		
	277V	3K 3000K		BZ Bronze		F Fuse	
		35K 3500K		WH White			
		4K 4000K		SL Silver			
			CC Custom Color				

REMOTE DRIVER & BATTERY BACKUP

FCD481R	UNV			1L				
SERIES	VOLTAGE	CCT	LUMENS	Finish	ACCESSORIES			
FCD481R¹	UNV 120-277V	27K 2700K	1L 165 lm (4W)	BK Black	PVC PVC Housing			
		3K 3000K		BZ Bronze		F Fuse		
		35K 3500K		WH White	BBUR¹ Battery Backup Remote (Indoor)			
		4K 4000K		SL Silver	BBUX² Battery Backup Remote (Outdoor)			
			CC Custom Color	N/A Leave Blank for Remote Driver Only (without Battery Backup)				

¹ LED DRIVER REMOTE (INDOOR) IP20, IK08, NEMA 1, -20°C to +50°C, 30' MAX Distance with 12AWG.

*Consult factory for outdoor remote driver only.

¹ Battery Back-up & LED Driver Remote (INDOOR), IP20, IK08, NEMA 1, 0°C to +48°C, 30' MAX Distance with 12AWG (w/UNV Option Only)

² Battery Back-up & LED Driver Remote (OUTDOOR), IP67, IK10, NEMA 4X, -20°C to +55°C, 30' MAX Distance with 12AWG (w/UNV Option Only)

SPECIFICATION

MOUNTING

- Concrete pour with **PVC** accessory.

CONSTRUCTION

- Corrosion resistant, heavy walled, solid die-cast aluminum construction.
- Lens is clear, polycarbonate.
- Neoprene continuous closed cell urethane 'O' ring gasket to seal out contaminants. Captive and recessed stainless steel, tamper resistant hex socket screws.

LED

- Lumens stated are delivered out of the luminaire. LED lifetime is greater than or equal to 70,000 hours with the lumen depreciation greater than L70. All of our luminaires are tested to LM 80 with a minimum CRI of 80 and color consistency of step 4 SDCM. Integral power supply standard. Input voltage 120V or 277V. Consult factory for dimming and any single color options.

FINISH

- Six stage chemical iron phosphate conversion pre-treatment. Polyester powder coat finish, 18 µm Min., 5000hr salt spray test (ASTM B117) compliant with Florida / AAMA 2604 specification.

LISTING

- ETL listed for interior and exterior wet locations. IP67 rating.

warranty

- 5 year limited warranty

Due to continuous development and improvements, specifications are subject to change without notice. FC Lighting reserves the right to change lab test details or specifications without notice. Product use certifies agreement to FC Lighting terms and conditions. FCC Series Cylinder Lights are engineered and produced in our Illinois manufacturing facility.

PHOTOMETRY

FCD481 120V LED 4000K 165 Lumens

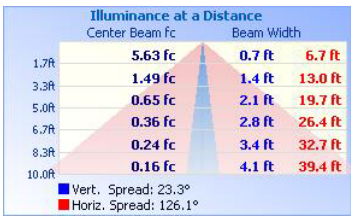
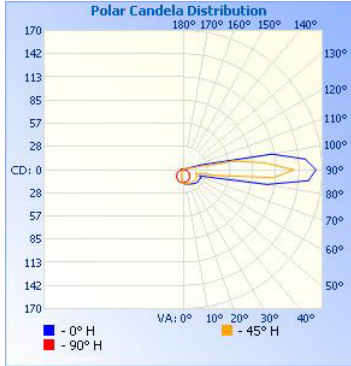

FCD484 120V LED 4000K 535 Lumens

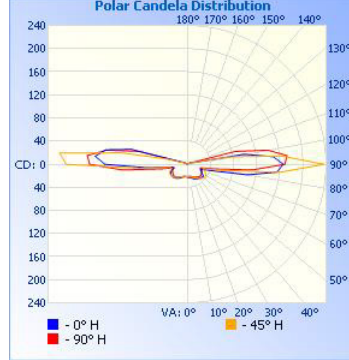

ACCESSORIES – PVC Housing

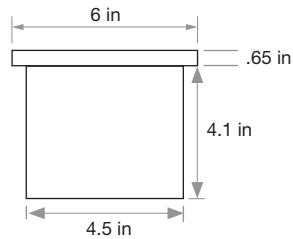

DIMENSIONS

FCD481

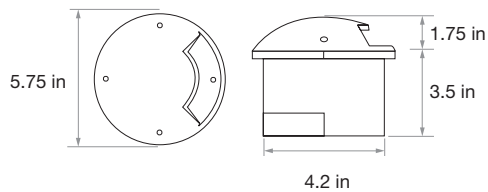

Due to continuous development and improvements, specifications are subject to change without notice. FC Lighting reserves the right to change lab test details or specifications without notice. Product use certifies agreement to FC Lighting terms and conditions. FCC Series Cylinder Lights are engineered and produced in our Illinois manufacturing facility.

BATTERY BACK-UPS

BBUR - BATTERY BACK-UP & LED DRIVER REMOTE (INDOOR), IP20, IK08, NEMA 1, 0°C to +48°C, 30' MAX Distance with 12AWG (w/UNV Option Only)

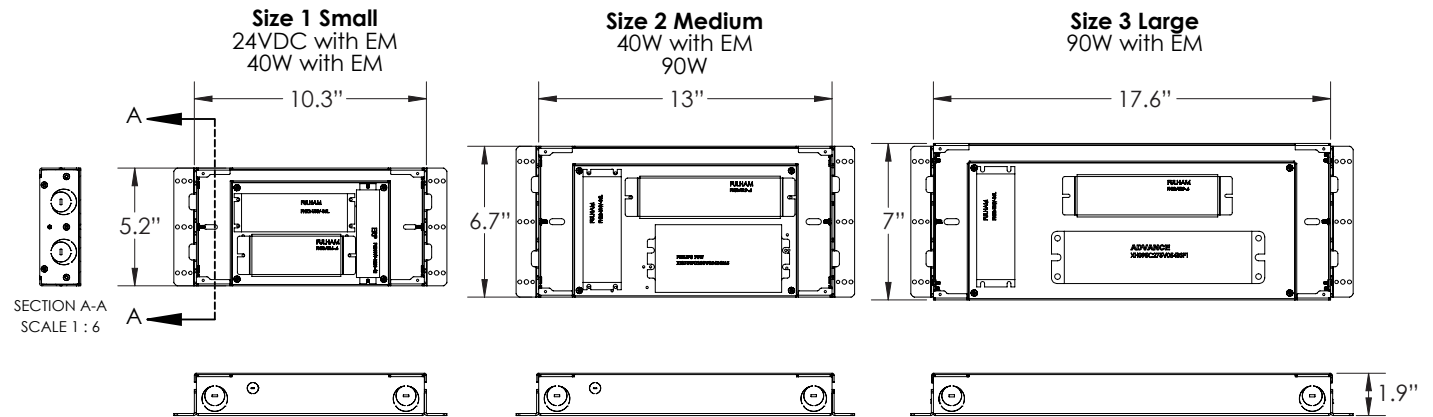

BBUX - BATTERY BACK-UP & LED DRIVER REMOTE (OUTDOOR), IP67, IK10, NEMA 4X, -20°C to +55°C, 30' MAX Distance with 12AWG (w/UNV Option Only)

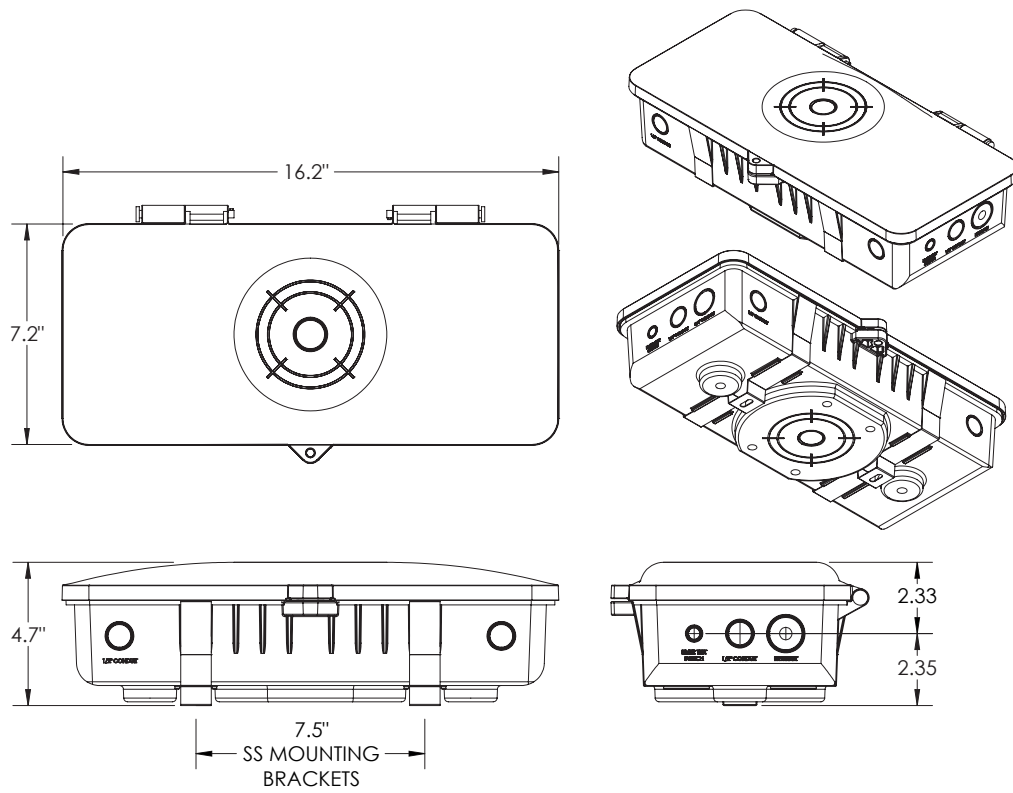

Due to continuous development and improvements, specifications are subject to change without notice. FC Lighting reserves the right to change lab test details or specifications without notice. Product use certifies agreement to FC Lighting terms and conditions. FCC Series Cylinder Lights are engineered and produced in our Illinois manufacturing facility.